

Q6. UBH13 with SLDHH13 x 1, CH13 and RES3 x 1 (Low)

Battery Side of Vehicle

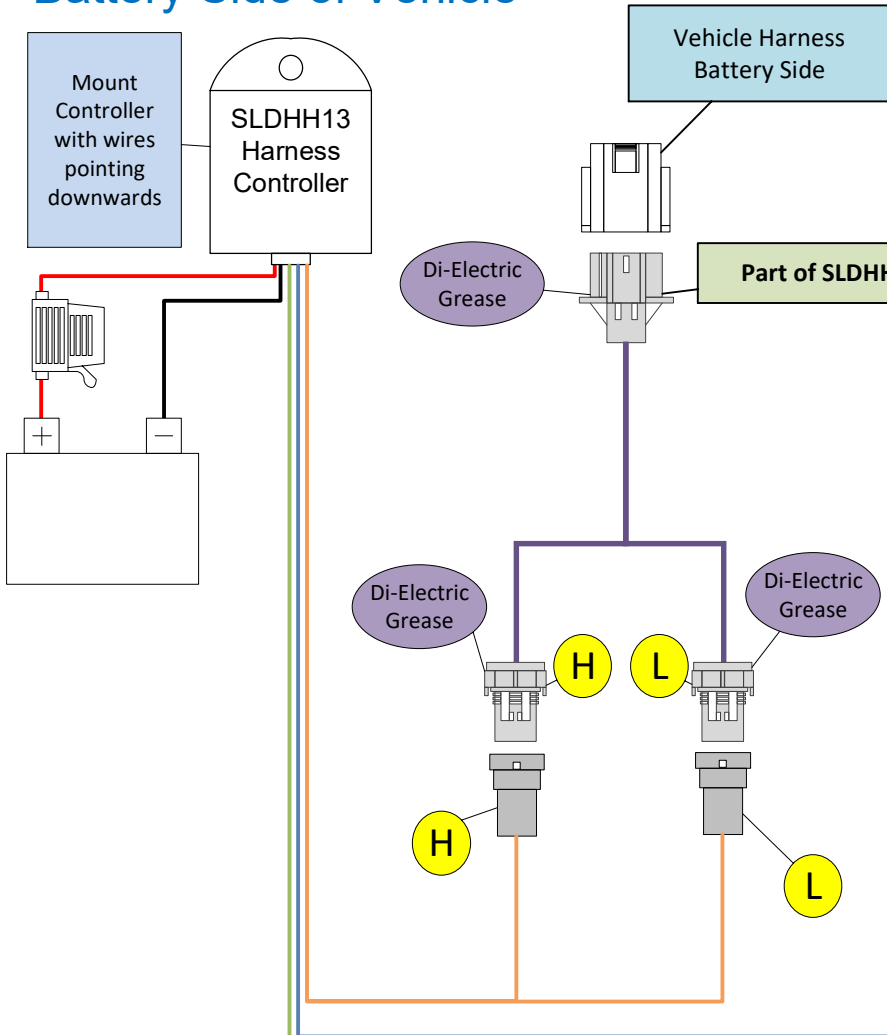

Opposite Side of Battery

